

# Preface

Thanks for using Tornado T8 dry and wet floor grinding machine.

T8 floor grinding machine is the new generation equipment independently developed by Tornado which is the multi-function equipment integrating the grinding, renovating, polishing, crystallization and cleaning into one. It has greatly improved the surface preparation and maintenance efficiency of the concrete, stone and epoxy floor so as to meet the high-standard requirements of floor surface treatment and maintenance as well as largely saved the construction time and cost.

This manual makes a detailed description for the application, maintenance, precaution, fault diagnosis and countermeasures of T8. It is the instructive document for your right application in its excellent performance and safe operation, please read it carefully and keep it properly.

If there is any problem or special requirement in application, please contact us in any time, and we will offer you the warm-hearted service.

We are always commits to the constant innovation and improvement for the equipment. If there are any changes for the relevant information of this equipment of this type, we will update it as soon as possible, for the inconvenience during this period, please understand.

## Contents

Preface .....	1
Chapter I Safety and Precautions.....	2
1.1 Safety Guide.....	3
1.2 Precautions.....	4
Chapter II Purchase Check, Technical Parameter and Product Description.....	5
2.1 Purchase Check.....	6
2.2 Nameplate and Model Description.....	7
2.3 Technical Parameter Description .....	8
2.4 Product Description .....	9
2.4.1 Product Structure Description .....	10
2.4.2 Main Product Feature .....	11
2.4.3 Product Desing Concept .....	12
Chapter III Operation Instruction .....	13
3.1 Equipment Operation Method.....	14
3.1.1 Equipment Operation Preparation.....	7
3.1.2 Mechanical Operation.....	7
3.2 Equipment Storage after Use.....	7
3.3 Instructions for using Floor Grinding Machine.....	9
3.4 Equipment Dismounting Steps and Precaution.....	9
3.4.1 Carring Steps.....	9
3.4.2 Notes for Carring.....	9
Chapter IV Equipment Wiring and Inverter Reset .....	10
4.1 Notices for Wiring .....	10
4.2 The general wiring diagram of switch box, inverter and motor. ....	10
4.3 Real object of Switch Box & Inverter....	11
4.4 Real object of Motor Wiring & Indicating Lights.....	11
4.5 Inverter Reset .....	11
Chapter V Equipment Maintenance and Overhauling.....	12
5.1 Maintenance and Overhauling .....	12
Chapter VI Quality Assurance .....	13
6.1 Warranty Scope and Period.....	13
6.2 Warranty Condition.....	20

# Chapter I

## Safety and Precautions

For the sake of safety of you, the equipment and the property, before using the machine, please make sure to read this manual carefully, and strictly follow it in the process of transporting, commissioning, operating and troubleshooting.

### 1.1 Safety Guide

[1]: The operating personnel must wear the water-proof and insulating work shoes and gloves, and barefooted operation is prohibited for preventing personal casualty from electric leakage.

[2]: The external connecting wire had better be more than 4m<sup>2</sup> and must be connected with the earth wire for preventing form electric leakage.

[3]: Before using the equipment, must check whether the power wire is damaged or aging. If so, immediately replace the power wire for preventing the equipment from short circuit and electric leakage.

[4]: The staff sitting on the electric machine of the equipment is prohibited for preventing equipment shut-down for over-load or personal casualty for electric leakage. Don't put the equipment, the power and the socket into water or over-humid environment for preventing the equipment damage from the short circuit.

[5]: When conducting wet grinding, waterproof protection should be conducted for the water tank, inverter and control panel for preventing the equipment non-operation or personal casualty from equipment short circuit or electric leakage.

[6]: When using the equipment, don't roll on the electric wire for preventing potential safety risk from electric wire damage.

[7]: When using the equipment, don't insert the plug with wet hands for preventing injuries and deaths from electric shock.

### 1.2 Precautions

[1]: After dry grinding and wet grinding treatment, there needs to completely clean the bottom part of the equipment so as to increase the service life.

[2]: When conducting dry grinding on the equipment, please connect the vacuum cleaner, so as to ensure the dust-free operation, decrease the inverter load and guarantee the equipment' s normal running.

[3]: In the process of replacing consumables and transporting, please be sure to put down the equipment gently for preventing the strike and oil leakage of the gear box from the improper operation (If one person can' t carry the equipment easily in the operation process, please look for other people to assist).

[4]: In a certain range of output frequency, the frequency inverter may probably produce the resonance which will cause the equipment to stop work, under such a circumstance, please avoid the resonant frequency operation.

[5]: When conducting the operation on the floor with a large difference of level, please be sure to grind from the higher to the lower for preventing the damages for the grinding plate and gear box from oversize difference of level.

[6]: Regularly check the grinding plate, if there finds any loose of the grinding plate, please make timely maintenance.

# Chapter II

## Purchase Check, Technical Parameter and Product Description

### 2.1 Purchase Check

- [1]: Please check whether the product package is damaged for improper transportation before opening the case.
- [2]: Check whether the specification and the model of the product conform to those of the purchased machine.
- [3]: All Tornado T8 floor grinding machines have passed the strict test and quality inspection. Please check whether there are certificate of quality, product user manual and warranty card.
- [4]: Check whether there are any damages inside of the machine. If there are obvious damages, please don't operate and use the machine, and timely contact our company or the dealer to avoid accidents.
- [5]: Check whether the items are complete, including one set of machine and standard fittings (the standard fittings are as follows).



Model	Wire	Lever	Splash Guard	Extra Weight/30KG	Velcro Holder
T8	10Meters	2PCS	1PCS	1PCS	9PCS

### 2.2 Nameplate and Model Description

MODEL  
T 8

MOTOR 10 HP

VOL 380 V

SERIAL NO.  
[ ]

DATE  
[ ]

FLOOR POLISHING MACHINE

MODEL: E5-H-4T7.5G-14  
 POWER: 7.5KW  
 INPUT: AC3PH 380-480V 50/60Hz 19A  
 OUTPUT: AC3PH 0-480V 0-300Hz 17A

S/N: [Barcode]

3-PHASE INDUCTION MOTOR CE

3-motor	HM2-132M-4	Eff. cl 3	Ins. cl. F	Date ****			
DE Brg.	6308ZZ	MDE Brg.	6308ZZ	NO. *****			
std.	*****	IR. 55	S 1	69kg			
KW	V	HZ	Conn	A	R/min	y	cosφ
7.5	220	50	△	26.9	1440	87.1%	0.84
7.5	380	50	Y	15.5	1440	87.1%	0.84

Nameplate of T8 equipment

Nameplate of inverter

Nameplate of motor

## 2.3 Technical Parameter Description

Model	T8
Voltage	380-440V
Current	15.5A
Motor	10HP(7.5KW)
Inverter	10HP(7.5KW)
Frequency	50/60HZ
Rotating Speed	450-2000RPM
Working Area	650MM
Grinding Disc	250MM*3
Water Tank	30L
Weight	270KGS
Dimension	970MM*650MM*950MM

## 2.4 Product Description

### 2.4.1 Product Structure Description



#### **2.4.2 Main Product Feature**

[1]: U-handle, which can rotate around 360°, and is safe and reliable with convenient operation conforming to the ergonomics.

[2]: Special big multi-functional magnet chassis, which enables the grinding material installation and replacement to be more convenient and quicker, and the high-speed running to be safer.

[3]: The central integrated design of the control panel, which can choose the speed specific to different grounds, improve the equipment stability and achieve the low-noise working environment.

[4]: The built-in vacuum cleaner connection device, which can achieve the dust-free working environment, thus good for staff's health and equipment's maintenance.

[5]: Easy operation, which enables the staff to easily complete the whole construction process by strictly following the manual.

#### **2.4.3 Product Design Concept**

In order to satisfying the high-quality floor pursuit of our country' s concrete and stone industry in recent years, our company has independently developed a professional dry and wet amphibious floor grinding machine integrating multi-functions of grinding, polishing and refurbishing into one so as to meet the grinding, polishing and refurbishing requirements of various kinds of floor.

# Chapter III

## Operation Instruction

### 3.1 Equipment Operation Method

#### 3.1.1 Equipment Operation Preparation

[1]: Firstly check whether the power switch is in the off state to ensure the safety.

[2]: As shown in the following Figure 1, firstly adjust the handle in the line-style, and then hold the location of the handle designated by ② with one foot stamping on ① to press downwardly with strength; after the equipment is fixed in the post, begin to check whether the external parts are complete, whether there are wrong installation, neglected installation and loose parts. Immediately solve the problem when finding those phenomena.

[3]: After checking, make the equipment down until the chassis touch the ground, and lay it flatly.

[4]: Load the grinding material onto the equipment chassis, and the basic steps are shown in Figure 2:

(1) As shown in Figure 2-1, the equipment chassis is loaded with small black grinding head.

(2) As shown in Figure 2-2, paste the piece with nylon viscose cloth of the required water milling slice to the small black grinding head, and paste one set of grinding slice onto the small black grinding head in sequence. Note: The number of grinding slices in one set of process must be consistent.

(3) After well loading, check whether the parts are complete once again.

[5]: Install or tighten the handle, clockwise rotate the black rotary handle to the tightest state. Rotate in the reverse direction when dismantling the handle as shown in Figure 3.

[6]: Pull the handle of the swing arm, adjust the handle to the height best suitable using the chuck as shown in Figure 4.



Figure 1

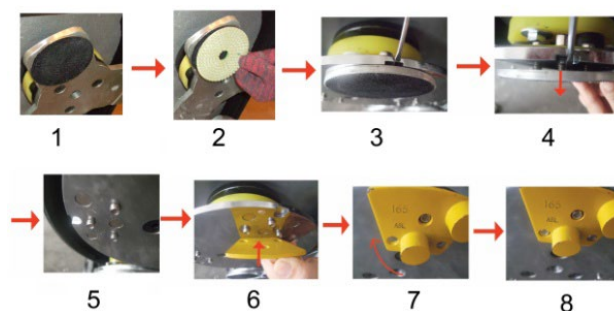

Figure 2



Figure 3

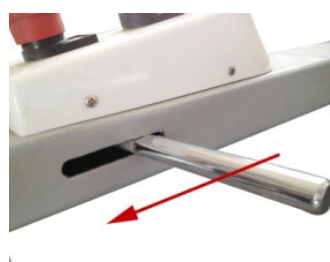

Figure 4

### 3.1.2 Mechanical Operation

- [1]: Check whether the voltage whereabouts is normal, and then connect both ends of the power wire into the corresponding plug as shown in Figure 5. As shown in Figure 6, if the red indicating light is on, everything is okay. When began to operate, if the green indicating light next is on, the equipment is in normal running state.
- [2]: The co-rotation and inversion switch control the grinding direction, if the switch is on the forward, it grinds clockwise; if it is on the inversion, it grinds reversely. The real object of co-rotation and inversion switch is as shown in Figure 7.
- [3]: The chassis rotation direction is as shown in Figure 8 and 9.
- [4]: The rotation speed controller can regulate the grinding speed, and clockwise rotation means speed up, counter clockwise rotation means slow down. The real object of rotation speed controller is as shown in Figure 10.
- [5]: When conducting water grinding, infuse proper amount of water into the water tank and regulate the water switch. When the water switch rotates clockwise, it begins infusing water, and stopping infusing when it rotates counter-clockwise. The real object of water switch and the water pipe joint are as shown in Figure 11.
- [6]: When dry grinding, the equipment can connect with the vacuum cleaner to ensure dust-free operation.

The connector of vacuum cleaner is as shown in Figure 12, and the equipment connecting with the vacuum cleaner are as shown in Figure 13, 14, 15 and 16.

Figure 13 shows the vacuum cleaner socket on the equipment.

Figure 14 is a picture about sweep-up pipe connecting.

Figure 15 is an overall connecting diagram of the equipment and the vacuum cleaner.

- [7]: When everything is ready, turn on the power switch and regulate it to an appropriate rotation speed to grind in a “double-cross” shape.



Figure 5

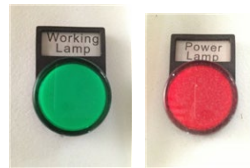

Figure 6



Figure 7



Figure 8 (Forward)



Figure 9 (Reverse)

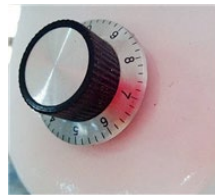

Figure 10



Figure 11



Figure 12



Figure 13



Figure 14



Figure 15



Figure 16

## 3.2 Equipment Storage after Use

- [1]: Place the hand into the vertical position, disconnect and place the power wire in dry place.
- [2]: Dismount the small grinding head from the machine, and then clean and dry them.
- [3]: Use a piece of half-dry clean rag to clean the machine. Pay attention to cleaning the machine surface after being used in wet environment.



[4]: Use dry rag to clean the dust on air vent of the inverter and the motor for preventing fault from dust blocking in the next application.

[5]: Check whether the whole machine and the accessories are in good condition, and make necessary repair and maintenance before storage.

[6]: Keep the machine in the clean and dry place, and when storing, place the handset in the vertical position and fasten tightly.

### 3.3 Instructions for using Floor Grinding Machine

[1]: In flattening the base plane, mount the diamond tool on the machine and grind in “double-cross” shape until being flat.

[2]: Clean the ground dust and fix up loopholes.

[3]: Paint oil painting or adhesion agent onto it according to the floor type and technique requirement.

### 3.4 Equipment Dismounting Steps and Precaution

#### 3.4.1 Carrying Steps

[1]: Firstly, pull up the power plug lightly.

[2]: If dismounts after dry grinding, please first to disconnect the vacuum cleaner; if dismounts after wet grinding, please first to wipe out the redundant water in the water tank.

[3]: As shown in Figure 17, insert and lock the lifting bar into the socket.

[4]: As shown in Figure 17, one person lifts the lifting bar at ①, and one person lifts the handle at ②. Two persons cooperate well to make strength at the same time to lift up the machine frame lightly, and place it appropriately.



Figure 17

### **3.4.2 Notes for Carrying**

[1]: Before carrying the machine, make sure the power switch is in off state, and there' s no redundant water in the water tank.

[2]: When carrying, please act lightly and carefully so as to avoid collision with the small parts and the wall; if one person can' t complete this operation independently, please deploy other persons to assist.

[3]: When knock-down shipping, be sure to well store all dismantled parts or screws for preventing loss.

[4]: After using the lifting rob, return it to the original place for next using.

## **Chapter IV**

# **Equipment Wiring and Inverter Reset**

Wiring the equipment, please be sure to operate strictly as per the following instruction, so as to prevent unnecessary loss.

## **4.1 Notices for Wiring**

[1]: If there need self-wiring, it must be operated under the instruction of professional electricians or the technicians of the manufacturer.

[2]: The electrical system of this equipment must strictly follow the parameters (voltage and frequency) designated on the nameplate, and before being connected with the input power, please check and ensure the voltage and the frequency of the external power supply are coincident.

[3]: This equipment must be connected to the power system equipped with grounded electrically for preventing the electric shock of the operator.

Note: The power wire (380V) of this equipment is equipped with 3 main traverse wire, 1 ground wire and 1 null wire. Connect the plug into appropriate power socket. The green-and-yellow core wire in the power wire is the ground wire, and don' t connect the ground wire to non-power socket.

## **4.2 The general wiring diagram of switch box, inverter and motor**

Circuit diagram of the Inverter (380v)

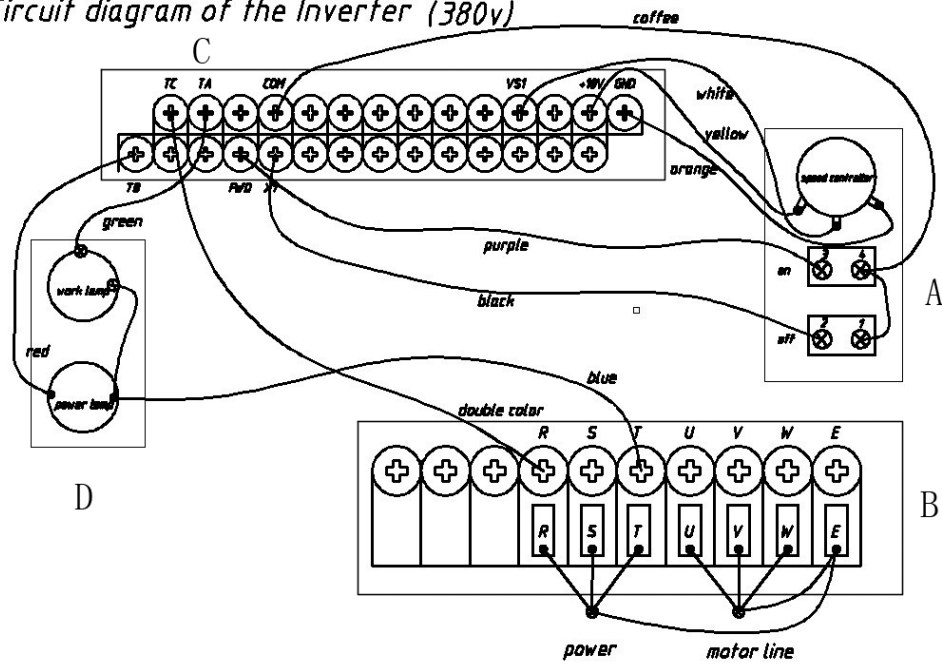

Figure 18

### 4.3 Real object of switch box & inverter



For switch box wiring details, please refer to Part A in Figure 18.

For inverter wiring detail, please refer to Part B and C in Figure 18.

### 4.4 Real object of motor wiring box & indicating lights



For motor wiring detail, please refer to Part B in Figure 18.



The indicating lights wiring details are as shown in Part D of Figure 18.

### 4.5 Inverter Reset

When the equipment is shut down because of over-low voltage or overload, please turn off the power supply. Turn on the power supply again after three minutes, and the equipment will recover to normal work. If not, use the control panel to reset (reset setting is as shown in Figure 19). The control panel of inverter is as shown in Figure 20.

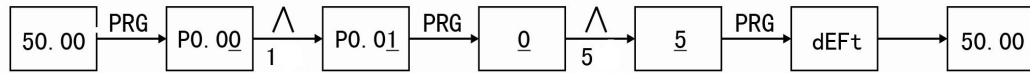

Figure 19

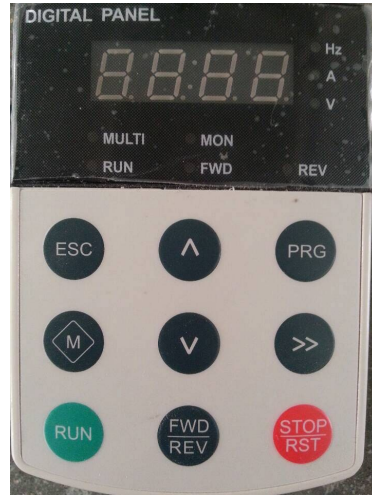

Figure 20

## Chapter V

# Equipment Maintenance and Overhauling

## 5.1 Maintenance and Overhauling

[1]: Make the working personnel check the grinding plate before using, if finds any loose of the grinding plate or the bolt, please timely fasten the bolt and the nut for timely preventing uneven abrasion.

[2]: In the process of using this equipment to grind, the working personnel shall notice the loss of grinding material for preventing the damage of grinding plate from it touching the ground.

[3]: When using, this machine can't block the vent hole. When being blocked, timely clean it to ensure the normal ventilation of the motor.

[4]: After 20 days in using, please clean the dust in the inverter and the vent hole, and the operation can be done after trouble shooting. In case of dry grinding in non-vacuum cleaner connection, it need to clean the dust in the inverter every 2 days.

[5]: When conducting dry grinding with this equipment, it must be equipped with the vacuum cleaner.

[6]: Please replace the gear oil (150#) regularly. The new machine needs to replace the gear oil after grinding for about 1000m<sup>2</sup>, and once every 5 months after the run-in period.

[7]: Clean the external housing of this equipment after using every time in the premise of outage, and put it in dry and cool place for next using, thus extending the service life.

[8]: Please operate this equipment strictly following the instructions, so as to avoid unnecessary person and property loss.

# Chapter VI

## Quality Assurance

### 6.1 Warranty Scope and Period

The warranty period of the motor, inverter and gear box of this equipment is 1 year since the purchasing day, and that of the vulnerable parts, such as water switch, stand, handle and chassis, is 3 months.

### 6.2 Warranty Condition

[1]: In the premise of the operation strictly following this manual, the damage of warranted parts for non-improper man-made operation, the manufacturer will provide free repair and replacement.

[2]: In case of self-repair of the purchase party, it must obtain the manufacturer' s approval, and the self-repair must be done under the instructive program; otherwise, the manufacturer will assume no legal responsibility.

[3]: For equipment faults caused by improper dismounting, our company will charge maintenance fee.

[4]: Please keep the warranty card properly and present it when seeking warranty repairing. Otherwise, we will not deal with that.

[5]: In the warranty period, the vulnerable parts which are judged as man-made deliberate damages are not within the warranty scope.

[6]: In the operation process, the burnout or damages of the motor and inverter caused by abnormal voltage (eg. the voltage range of T2 is 220-240V, the construction voltage in America is 380-440V, three-phase, which are all abnormal voltage for this equipment) are not within the scope of warranty.

[7]: When the machine, which is still within the warranty period, can' t normally run caused by wrong wiring method and must be overhauled by our company' s technician, and if the problem is proved to be the fault of the machine upon the inspection done by the overhauling technician, the travel expense and labor fee must be borne by the purchase party.